

TARA 2024





TARA

Una famiglia di lampade a parete o a soffitto dalle forme quadrate, rettangolari e rotonde, pensata per tutti gli ambienti.

Il bordo rientrante addolcisce le linee minimali, valorizzando esteticamente la lampada con la massima attenzione al dettaglio.

Materiali: corpo in alluminio verniciato bianco o nero raggrinzante. Diffusore in polimetilmetacrilato.

A family of wall or ceiling lamps with square, rectangular and round shapes, designed for all environments.

The recessed edge softens the minimalist lines, aesthetically enhancing the lamp with the highest attention to detail.

Materials: body in white or black wrinkle effect painted aluminium. Sandblasted polymethylmethacrylate diffuser.



Tara_R | topLED | 220-240 V | 17 W DC - 21 W AC

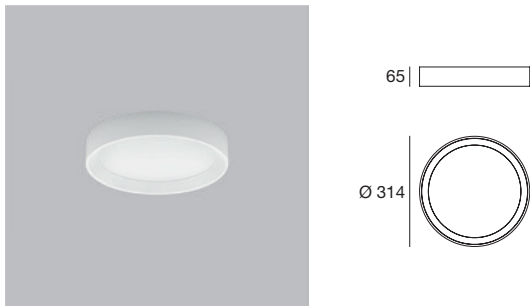

	CRI	UGR	Cct	lm S	lm D	Optic
8334	White	90	-	3000	2208 1764	Diffused
8335	Black	90	-	3000	2208 1764	Diffused

Tara_R | topLED | 220-240 V | 17 W DC - 23 W AC

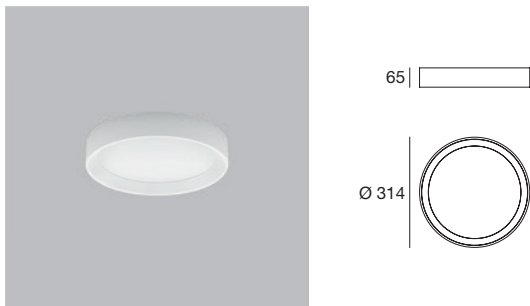

	CRI	UGR	Cct	lm S	lm D	Optic
CA004DWHMDI	White	90	-	2700	2054 1641	Diffused
CA004DBBMDI	Black	90	-	2700	2054 1641	Diffused
8590	White	90	-	3000	2208 1764	Diffused
8591	Black	90	-	3000	2208 1764	Diffused

Accessories

KIT0026	Phase-cut Dimmer (1-4 art. / max. 100 W)
----------------	--

Tara_R | topLED | 220-240 V | 27 W DC - 31 W AC

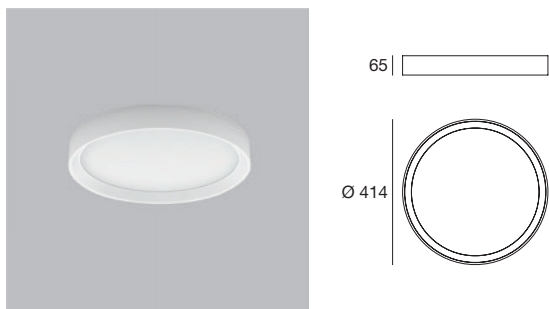

	CRI	UGR	Cct	lm S	lm D	Optic
8337	White	90	-	3000	3285 2466	Diffused
8338	Black	90	-	3000	3285 2466	Diffused

Tara_R | topLED | 220-240 V | 41 W DC - 46 W AC

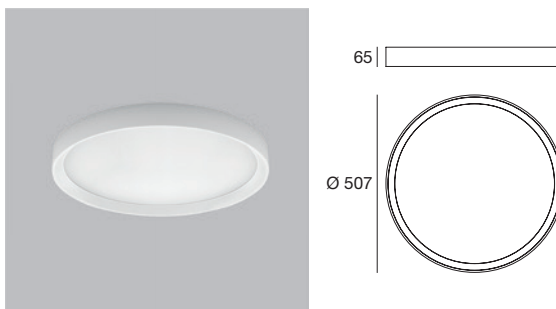

	CRI	UGR	Cct	lm S	lm D	Optic
8340	White	90	-	3000	4883 3525	Diffused
8341	Black	90	-	3000	4883 3525	Diffused

Tara_R | topLED | 220-240 V | 27 W DC - 33 W AC

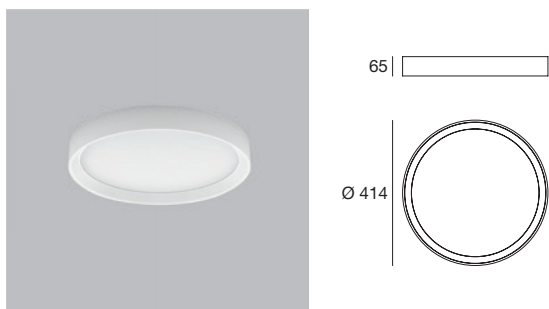

	CRI	UGR	Cct	lm S	lm D	Optic
CA005DWHMDI	White	90	-	2700	3056 2294	Diffused
CA005DBBMDI	Black	90	-	2700	3056 2294	Diffused
8593	White	90	-	3000	3285 2466	Diffused
8594	Black	90	-	3000	3285 2466	Diffused

Accessories

KIT0026	Phase-cut Dimmer (1-3 art. / max. 100 W)
----------------	--

Tara_R | topLED | 220-240 V | 41 W DC - 45 W AC

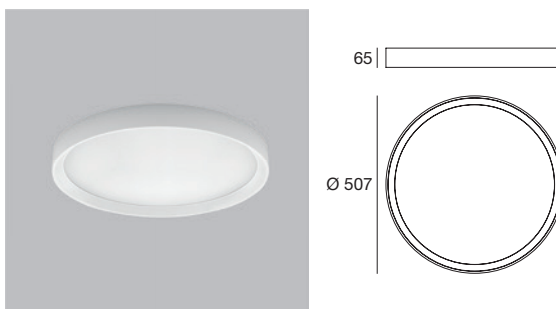

	CRI	UGR	Cct	lm S	lm D	Optic
CA006DWHMDI	White	90	-	2700	4542 3280	Diffused
CA006DBBMDI	Black	90	-	2700	4542 3280	Diffused
8596	White	90	-	3000	4883 3525	Diffused
8597	Black	90	-	3000	4883 3525	Diffused

Accessories

KIT0026	Phase-cut Dimmer (1-2 art. / max. 100 W)
----------------	--

Tara_Q | topLED | 220-240 V | 18 W DC - 21 W AC

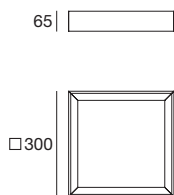

	CRI	UGR	Cct	lm S	lm D	Optic	
8325	White	90	-	3000	2336	1360	Diffused
8326	Black	90	-	3000	2336	1360	Diffused

Tara_Q | topLED | 220-240 V | 25 W DC - 31 W AC

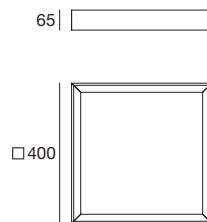

	CRI	UGR	Cct	lm S	lm D	Optic	
8328	White	90	-	3000	3228	1898	Diffused
8329	Black	90	-	3000	3228	1898	Diffused

Tara_Q | topLED | 220-240 V | 18 W DC - 23 W AC

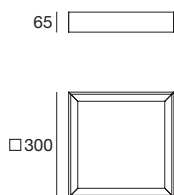

	CRI	UGR	Cct	lm S	lm D	Optic	
CA001DWHMDI	White	90	-	2700	2173	1265	Diffused
CA001DBBMDI	Black	90	-	2700	2173	1265	Diffused
8550	White	90	-	3000	2336	1360	Diffused
8551	Black	90	-	3000	2336	1360	Diffused

Accessories

KIT0026	Phase-cut Dimmer (1-4 art. / max. 100 W)
----------------	--

Tara_Q | topLED | 220-240 V | 25 W DC - 33 W AC

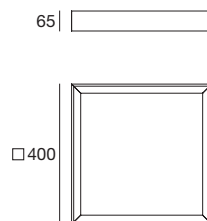

	CRI	UGR	Cct	lm S	lm D	Optic	
CA002DWHMDI	White	90	-	2700	3003	1765	Diffused
CA002DBBMDI	Black	90	-	2700	3003	1765	Diffused
8553	White	90	-	3000	3228	1898	Diffused
8554	Black	90	-	3000	3228	1898	Diffused

Accessories

KIT0026	Phase-cut Dimmer (1-3 art. / max. 100 W)
----------------	--

Tara_Q | topLED | 220-240 V | 39 W DC - 45 W AC

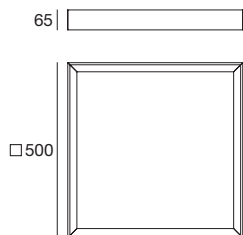

	CRI	UGR	Cct	lm S	lm D	Optic	
8331	White	90	-	3000	4700	2720	Diffused
8332	Black	90	-	3000	4700	2720	Diffused

Tara_Q | topLED | 220-240 V | 39 W DC - 45 W AC

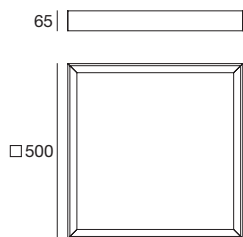

	CRI	UGR	Cct	lm S	lm D	Optic	
CA003DWHMDI	White	90	-	2700	4372	2530	Diffused
CA003DBBMDI	Black	90	-	2700	4372	2530	Diffused
8556	White	90	-	3000	4700	2720	Diffused
8557	Black	90	-	3000	4700	2720	Diffused

Accessories

KIT0026	Phase-cut Dimmer (1-2 art. / max. 100 W)
----------------	--



Tara_B | topLED | 220-240 V | 38 W DC - 44 W AC

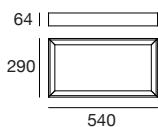

	CRI	UGR	Cct	lm S	lm D	Optic
CA007DWHMDI	White	90	-	2700	4354 2756	Diffused
CA007DBBMDI	Black	90	-	2700	4354 2756	Diffused
9015	White	90	-	3000	4680 2963	Diffused
9016	Black	90	-	3000	4680 2963	Diffused

Accessories

KIT0026	Phase-cut Dimmer (1-2 art. / max. 100 W)
----------------	--

Tara_B | topLED | 220-240 V | 24 W DC - 28 W AC

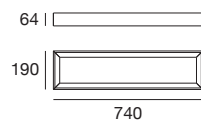

	CRI	UGR	Cct	lm S	lm D	Optic
CA008DWHMDI	White	90	-	2700	3304 1833	Diffused
CA008DBBMDI	Black	90	-	2700	3304 1833	Diffused
9018	White	90	-	3000	3552 1971	Diffused
9019	Black	90	-	3000	3552 1971	Diffused

Accessories

KIT0026	Phase-cut Dimmer (1-3 art. / max. 100 W)
----------------	--

Tara_B | topLED | 220-240 V | 38 W DC - 42 W AC

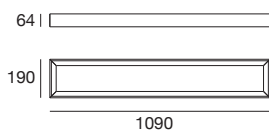

	CRI	UGR	Cct	lm S	lm D	Optic
CA009DWHMDI	White	90	-	2700	5036 2555	Diffused
CA009DBBMDI	Black	90	-	2700	5036 2555	Diffused
9021	White	90	-	3000	5414 2746	Diffused
9022	Black	90	-	3000	5414 2746	Diffused

Accessories

KIT0026	Phase-cut Dimmer (1-2 art. / max. 100 W)
----------------	--



Tara Maxi | topLED | 220-240 V | 51 W DC - 58 W AC

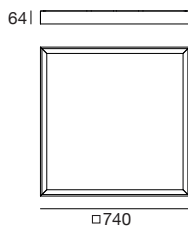

	CRI	UGR	Cct	Im S	Im D	Optic	
CA010DWHMDI	White	90	-	2700	5850	4343	Diffused
CA010DBBMDI	Black	90	-	2700	5850	4343	Diffused
9024	White	90	-	3000	6288	4669	Diffused
9025	Black	90	-	3000	6288	4669	Diffused

Accessories

KIT0026	Phase-cut Dimmer (1 art. / max. 100 W)
----------------	--

Tara Mega | topLED | 220-240 V | 66 W DC - 76 W AC

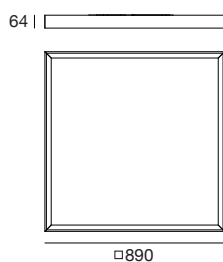

	CRI	UGR	Cct	Im S	Im D	Optic	
CA011DWHMDI	White	90	-	2700	7300	5476	Diffused
CA011DBBMDI	Black	90	-	2700	7300	5476	Diffused
9027	White	90	-	3000	7848	5887	Diffused
9028	Black	90	-	3000	7848	5887	Diffused

Accessories

KIT0026	Phase-cut Dimmer (1 art. / max. 100 W)
----------------	--









Condizioni generali di vendita:

1. Efficacia

- 1.1. Le presenti condizioni generali di vendita (di seguito le "Condizioni Generali") disciplinano e si applicano a tutte le forniture di Linea Light S.r.l. (di seguito "Linea Light") ai propri clienti (di seguito "Clienti" e singolarmente "Cliente" e congiuntamente di seguito "Parti" e singolarmente "Parte"). Le Condizioni Generali costituiscono parte integrante e sostanziale di tutti i contratti di fornitura e vendita.
- 1.2. Le condizioni generali del Cliente non saranno applicate, neppure se espressamente richiamate in ordini o conferme d'ordine accettati da Linea Light, salvo diverso ed espresso accordo scritto tra le Parti. Eventuali deroghe alle Condizioni Generali saranno efficaci solo se formalizzate per iscritto e sottoscritte da entrambe le Parti. Le presenti Condizioni Generali annullano e sostituiscono precedenti condizioni generali di Linea Light o del Cliente applicabili al rapporto. Resta in facoltà di Linea Light di modificare e/o sostituire in ogni momento le presenti Condizioni Generali. Le modifiche e/o sostituzioni avranno efficacia immediata e saranno opponibili ai Clienti non appena verranno loro comunicate per iscritto. Il Cliente avrà facoltà di non accettarle inviando comunicazione scritta a Linea Light. In difetto di approvazione delle modifiche e/o sostituzioni apportate da Linea Light, resteranno valide le corrispondenti clausole delle presenti Condizioni Generali.

2. Prodotti

- 2.1. Linea Light si riserva la facoltà di eliminare in qualsiasi momento e senza preavviso eventuali prodotti dalla collezione o modificare parti, dettagli o finiture al fine di migliorare le prestazioni dei prodotti o in osservanza alle normative CE.
- 2.2. Eventuali campioni dei prodotti o immagini degli stessi contenuti in cataloghi, prospetti, materiali pubblicitari, listini e/o simili hanno solo valore indicativo, anche qualora la vendita venga effettuata ai sensi dell'art. 1522 cod. civ.
- 2.3. Oggetto dei rapporti di fornitura disciplinati dalle Condizioni Generali sono sia i prodotti standard come pure quelli personalizzati, realizzati da Linea Light e/o, per conto della stessa, da terzi, nonché i prodotti semplicemente commercializzati da Linea Light. Sono personalizzati i prodotti realizzati su disegno o su progetto o comunque su specifica indicazione del Cliente od utilizzando conoscenze tecniche o tecnologiche dello stesso. Il Cliente per il quale siano stati realizzati prodotti personalizzati dovrà manlevare e tenere Linea Light indenne da qualsiasi pretesa di terzi, in particolare a titolo di concorrenza sleale, o per contraffazione o usurpazione di brevetti, marchi, modelli industriali, disegni e modelli ornamentali, o comunque per violazione di diritti di proprietà industriale o intellettuale, diritti d'autore o know-how in genere. Il Cliente si assume ogni responsabilità in relazione al prodotto personalizzato, ai sensi e per gli effetti di cui al D.Lgs. 06.09.2005 n. 206 e della Direttiva 85/374/CE e s.m.i., oltre che di analoghe disposizioni di legge applicabili nei Paesi in cui i prodotti verranno utilizzati e/o commercializzati, obbligandosi a manlevare e tenere indenne Linea Light da qualsivoglia pretesa di terzi, senza che il Cliente possa reclamare o eccepire alcunché a qualsivoglia titolo e/o ragione.

3. Ordini

- 3.1. Gli ordini dovranno essere effettuati per iscritto e trasmessi con le modalità indicate al punto 10.1 ed indicare con precisione il tipo e il numero di prodotti ordinati. Eventuali ordini trasmessi verbalmente non verranno presi in considerazione fino al ricevimento da parte di Linea Light del relativo documento scritto. Linea Light si riserva la facoltà di accettare o meno gli ordini ricevuti. L'accettazione potrà avvenire mediante comunicazione scritta trasmessa con uno qualsiasi dei mezzi di cui al successivo punto 10.1, oppure per fatti concludenti mediante il semplice inizio dell'esecuzione dell'ordine. In quest'ultimo caso Linea Light dovrà, entro un termine ragionevole, comunicare al Cliente di avere avviato l'esecuzione e di aver perciò accettato l'ordine.
- 3.2. Un'eventuale accettazione dell'ordine, da parte di Linea Light, non conforme allo stesso dovrà considerarsi una controproposta che si riterrà accettata dal Cliente se non contestata entro il termine di tre giorni dal suo ricevimento, senza, decorso detto termine, che il Cliente possa eccepire o reclamare alcunché a qualsivoglia titolo e/o ragione.
- 3.3. Gli eventuali agenti, procuratori d'affari ed altri ausiliari di commercio di Linea Light non hanno il potere di vincolare in alcun modo Linea Light. In particolare essi non hanno alcun potere di stipulare contratti per conto di Linea Light, modificare o annullare i contratti in corso, modificare i termini di consegna, concedere esclusive né di vendita né di acquisto, concedere sconti o abbuoni o dilazioni di pagamento, riscuotere somme di danaro, salvo i casi in cui siano muniti di regolare procura speciale e cioè conferita a tali determinati scopi. Qualora il Cliente effettui pagamenti ai soggetti sopra indicati, non sarà liberato e l'obbligo di pagamento non si considererà eseguito ed estinto, fino al momento in cui le relative somme non perverranno a Linea Light.
- 3.4. L'invio o comunque la consegna da parte di Linea Light, di suoi agenti, procuratori o di altri ausiliari di commercio, di listini prezzi o di materiale illustrativo dei prodotti non potrà in alcun modo considerarsi come proposta contrattuale.

4. Consegna

- 4.1. I termini di consegna indicati negli ordini, seppure accettati da Linea Light, o in altro modo pattuiti, non possono essere considerati essenziali e hanno valore meramente indicativo, salvo diverso ed espresso accordo tra le Parti. Una ragionevole tolleranza è sempre ammessa. Pertanto, in caso di ritardo nella consegna, Linea Light non sarà considerata in alcun modo inadempiente e nessuna eccezione potrà essere sollevata né alcuna pretesa potrà essere avanzata nei suoi confronti a tale titolo.
- 4.2. Salvo diverso accordo scritto tra le Parti, le consegne sono effettuate ex works (EXW), secondo la definizione Incoterms della Camera di Commercio Internazionale nella versione di volta in volta vigente. Il luogo di consegna sarà lo stabilimento di Linea Light. In caso di mancato ritiro della merce da parte del Cliente o di suo rifiuto di riceverla, anche nei casi in cui la consegna, per accordo scritto tra le parti, non debba avvenire EXW, Linea Light potrà procedere alla vendita dei beni non ritirati anche in deroga a quanto previsto dall'art. 1515 e ss. cod. civ., fermo ogni altro rimedio esperibile per legge o per contratto e in particolare contemplato dalle Condizioni Generali.

5. Prezzo – Termini e modalità di versamento

- 5.1. Linea Light si riserva la facoltà di apportare variazioni ai prezzi indicati senza preavviso.
- 5.2. I prodotti, salvo diverso accordo scritto tra le Parti, saranno forniti al prezzo risultante dal listino di Linea Light in vigore al momento di accettazione dell'ordine da parte di quest'ultima. Linea Light potrà liberamente cedere a terzi i crediti verso il Cliente originati dalle forniture. Il Cliente non potrà sospendere né ritardare il pagamento del prezzo per alcuna ragione e in particolare non potrà sollevare eventuali contestazioni, qualunque ne sia il titolo o la causale, in merito alla merce ricevuta se non dopo avere integralmente versato il relativo prezzo. Si precisa che il Cliente dovrà corrispondere integralmente e puntualmente il prezzo dovuto anche qualora non abbia ancora provveduto al ritiro della merce.
- 5.3. Salvo ogni altro rimedio previsto dal contratto, dalle Condizioni Generali e dalla legge, o concordato tra le Parti, in caso di ritardo nel pagamento del prezzo il Cliente sarà costituito automaticamente in mora e matureranno sulle somme dovute interessi moratori al tasso di cui al D. Lgs. 231/2002. Inoltre, il Cliente decadrà immediatamente dal beneficio del termine con riferimento ad ogni altro pagamento dovuto a Linea Light, senza necessità di alcuna previa comunicazione da parte di quest'ultima. Linea Light potrà sospendere ogni altra fornitura a favore di tale Cliente finché tutti i pagamenti, quello/i in relazione al/i quale/i si è verificato il ritardo e gli eventuali ulteriori divenuti esigibili a causa della decadenza dal beneficio del termine, siano stati integralmente corrisposti, fermo restando che, ove la merce da consegnare sia già stata prodotta, il Cliente sarà tenuto altresì al versamento di una somma pari allo 0,5% del prezzo della merce non ritirata per ogni settimana o frazione di essa di ritardo nel ritiro a titolo di spese di magazzinaggio, fermo l'obbligo di risarcire a Linea Light eventuali ulteriori danni. In tutti i casi previsti nel presente articolo 5.2 il Cliente non potrà eccepire o reclamare alcunché a qualsivoglia titolo e/o ragione.

6. Imballaggio

- 6.1. Salvo diverso accordo scritto tra le Parti, i prodotti verranno consegnati con imballo standard di Linea Light. Contestazioni circa danneggiamenti dell'imballo dovranno, a pena di decadenza, essere sollevate per iscritto dal Cliente, o dal vettore incaricato, all'atto del ritiro.

7. Garanzie

- 7.1. Linea Light garantisce al Cliente che i prodotti forniti sono esenti da vizi di fabbricazione e/o di materiale e la loro conformità alle applicabili norme italiane e comunitarie vigenti al tempo della consegna. Salvo specifico accordo diverso ed indicazione di determinate normative da individuarsi a rischio e pericolo del Cliente, il Cliente sopporterà ogni rischio di difformità dei prodotti ad altre normative. Linea Light garantisce i prodotti da vizi e difetti.
- 7.2. A pena di decadenza, il Cliente dovrà denunciare i difetti rinvenuti mediante comunicazione scritta a Linea Light entro 8 giorni dalla consegna ovvero dalla scoperta in caso di vizio occulto. In ogni caso, il Cliente decade dal diritto alla garanzia qualora non abbia adempiuto ai propri obblighi di pagamento nei termini convenuti. La denuncia dei difetti rilevati dovrà indicare con precisione la natura dei difetti riscontrati, il numero del lotto di Linea Light a cui appartengono i prodotti che si affermano viziati e eventuali prodotti consegnati a terzi o immessi sul mercato.
- 7.3. Il Cliente entro i termini di cui al precedente art. 7.2 dovrà spedire a propria cura e spese a Linea Light i prodotti che si affermano viziati. Qualora venga accertata l'esistenza di vizi o difetti di cui Linea Light sia tenuta a rispondere in base alle presenti Condizioni Generali, Linea Light provvederà a propria cura e spese alla sostituzione dei pezzi difettosi. In ogni caso, Linea Light non sarà in alcun modo tenuta al risarcimento di danni, diretti o indiretti, subiti dal Cliente.
- 7.4. La garanzia non opererà in caso di normale degrado d'uso dei prodotti e/o difetti o malfunzionamenti dovuti ad imperizia od uso difforme dalle istruzioni di Linea Light.
- 7.5. Il Cliente decade, altresì, dal diritto alla garanzia nell'ipotesi in cui abbia apportato modifiche ovvero abbia eseguito interventi di qualsiasi natura sui prodotti senza la preventiva autorizzazione scritta di Linea Light.
- 7.6. La durata della garanzia è di 24 mesi dalla consegna dei prodotti. Previa registrazione del Cliente sul sito www.linealight.com ed accettazione delle condizioni previste la durata della garanzia sarà di 5 anni decorrenti dalla data della fattura di vendita.
- 7.7. Non costituiscono vizio e/o difetto le variazioni nella tonalità della luce emessa dai LED (CCT della luce bianca, espressa in Kelvin; lunghezza d'onda dello spettro EM per la luce colorata, espressa in nanometri) né le variazioni di tonalità della colorazione dei vetri.

8. Esonero da responsabilità

- 8.1. In nessun caso Linea Light potrà essere ritenuta responsabile e, pertanto, viene espressamente esclusa qualsiasi responsabilità per danni diretti e indiretti nonché costi e spese in caso di violazione della garanzia di cui al precedente articolo 7 o qualsiasi altro obbligo di Linea Light derivante dalla vendita dei prodotti.

9. Riservatezza

- 9.1. Il Cliente non potrà divulgare a terzi né utilizzare in alcun modo informazioni sia tecniche che commerciali di Linea Light, scritte o orali che siano, in qualunque modo ricevute o apprese, anche semplicemente in occasione di visite presso gli stabilimenti di Linea Light. Detti obblighi non troveranno applicazione con riferimento a quelle informazioni che al momento della loro comunicazione da parte di Linea Light o comunque del loro apprendimento da parte del Cliente siano legittimamente di pubblico dominio. Detti obblighi resteranno in vigore, con riferimento ad ogni singola informazione, fino a che la stessa divenga legittimamente di pubblico dominio.

10. Comunicazioni

- 10.1. Ogni avviso od altra comunicazione richiesta od ammessa dalla Condizioni Generali o dal contratto di fornitura avverrà per iscritto e potrà essere consegnata a mani, inviata per corriere o per raccomandata con avviso di ricevimento, trasmessa per e-mail o PEC, salvo specifica diversa indicazione.

11. Disposizioni generali

- 11.1. Il Cliente non acquisirà in forza del contratto di fornitura alcun diritto su marchi e loghi di Linea Light.
- 11.2. Nessuna Parte sarà ritenuta responsabile per ritardo o altra forma di inadempimento ad una o più disposizioni delle Condizioni Generali o del contratto di fornitura nel caso in cui ciò sia dovuto a causa di forza maggiore. Si considerano, a titolo meramente indicativo, cause di forza maggiore eventi naturali eccezionali, tra cui terremoti, alluvioni e simili, crolli, incendi, scioperi, non solo nazionali, ma anche locali e aziendali, serrate, tumulti, atti terroristici, difficoltà negli approvvigionamenti e nei trasporti, pandemie, provvedimenti dell'autorità, nonché, per quanto attiene Linea Light, fermi di produzione dovuti alla necessità di operazioni di manutenzione, riparazione o rifacimento di impianti o immobili, anche se causata da un'errata o insufficiente manutenzione effettuata nel passato. Tale Parte dovrà comunque darne immediata comunicazione all'altra, che avrà diritto di recedere dal Contratto stesso nel caso in cui l'evento di forza maggiore perduri per un termine superiore a sei mesi.

12. Legge applicabile e foro competente

- 12.1. Le Condizioni Generali e tutti i contratti di fornitura tra Linea Light e i Clienti sono disciplinati dalla legge italiana, con esplicita esclusione della Convenzione di Vienna sulla vendita internazionale di beni mobili del 1980 e delle norme di conflitto.
- 12.2. Per ogni e qualsiasi controversia nascente dalle Condizioni Generali e/o da qualsiasi contratto di fornitura, o ad esse/essi relativa sarà competente in via inderogabile ed esclusiva il Foro di Treviso.

General terms and conditions of sale:

1. Effectiveness

- 1.1. These general sales conditions (hereinafter, "General Terms") regulate and apply to all supplies by Linea Light S.r.l. (hereinafter, "Linea Light") to its clients (hereinafter, "Clients" and severally "Client", and hereinafter jointly "Parties" and severally "Party"). The General Terms constitute an integral and substantial part of all sale and supply agreements.
- 1.2. The Client's general terms shall not be applied, not even if expressly cited in orders or order confirmations accepted by Linea Light, unless otherwise and expressly agreed in writing between the Parties. Any exceptions to the General Terms shall be effective only if formalised in writing and subscribed to by both Parties. These General Terms cancel and replace any previous general terms of Linea Light or of the Client applicable to the relationship. Linea Light reserves the right to modify and/or replace these General Terms at any time. The changes and/or substitutions shall have immediate effect vis-à-vis Clients as soon as they are communicated in writing. The Client shall have the right not to accept them, notifying Linea Light in writing. In the absence of approval of the changes and/or substitutions made by Linea Light, the corresponding clauses of these General Terms shall remain valid.

2. Products

- 2.1. Linea Light reserves the right to eliminate products from the collection or to modify parts, details or finishings for the purpose of improving the performance of the products or in observance of EC regulations.
- 2.2. Any product samples or images contained in catalogues, prospectuses, advertising materials, price lists and/or similar have only an indicative value, even in the event the sale is made pursuant to art. 1522 of the Italian Civil Code.
- 2.3. The object of the supply relationships regulated by the General Terms are both standard products and custom products developed by Linea Light and/or, on its behalf, by third parties, as well as products simply marketed by Linea Light. Custom products are those developed according to a design or project, or in any case according to the Client's specific instructions or else using the latter's technical or technological knowledge. The Client for whom custom products have been developed shall indemnify and hold harmless Linea Light from any third-party claims, in particular due to unfair competition or counterfeiting or usurpation of patents, brands, industrial models, drawings and ornamental models, or in any case the violation of industrial or intellectual property rights, copyrights or know-how in general. The Client assumes all responsibility in relation to the custom product, pursuant to and for the purposes of Legislative Decree no. 206 dated 06/09/2005, and Directive 85/374/CE and subsequent amendments, in addition to similar legal provisions applicable in the country in which the Products will be used and/or marketed, undertaking to indemnify and hold harmless Linea Light from any third-party claims, without the Client being able to claim or raise any objections in any capacity and/or for any reason.

3. Orders

- 3.1. Orders must be made in writing and transmitted according to the methods indicated in article 10.1, precisely indicating the type and number of products ordered. Any verbally transmitted orders shall not be taken into consideration until such time as Linea Light receives the relative written document. Linea Light reserves the right to accept or refuse the received orders. Acceptance can occur by way of written communication transmitted using any of the means referred to in article 10.1 below, or by way of conduct by simply commencing execution of the order. In the latter case, Linea Light shall, within a reasonable term, notify the Client that execution has commenced and that the order has therefore been accepted.
- 3.2. Any acceptance of the order by Linea Light that does not comply with said order, shall be considered a counter-offer, which shall be deemed accepted by the Client if not disputed within three days from its receipt, after which time the Client shall not be able to claim or raise any objections in any capacity and/or for any reason.
- 3.3. Any agents, brokers and other auxiliaries to trade of Linea Light do not have the power to bind Linea Light in any way. In particular, they do not have the power to stipulate agreements on behalf of Linea Light, modify or cancel agreements in force, modify delivery terms, grant exclusivity agreements for neither sale nor purchase, grant discounts or rebates or deferred payment plans, collect sums of money, unless they are in possession of a regular special power of attorney issued for said specific purposes. If the Client makes payments to the aforementioned subjects, it shall not be released and the obligation for payment shall not be considered fulfilled and extinguished until such time as the relative amounts are received by Linea Light.
- 3.4. The sending or in any case delivery by Linea Light, its agents, brokers or other auxiliaries to trade, of price lists or illustrative materials in relation to the products shall in no way be considered a contractual offer.

4. Delivery

- 4.1. The delivery terms indicated in the orders, albeit accepted by Linea Light or agreed upon using other methods, cannot be considered binding and shall have a merely indicative value, unless otherwise and expressly agreed between the Parties. A reasonable tolerance is always allowed. Therefore, in case of delayed delivery, Linea Light shall not be considered in any way in default and no objections can be raised, nor can any claims be made against Linea Light in this respect.
- 4.2. Unless otherwise agreed in writing between the Parties, deliveries shall be made ex works (EXW), according to the Incoterms definition of the International Chamber of Commerce in its most up-to-date version. The place of delivery shall be the Linea Light facility. In case of non-collection of goods on the part of the Client or refusal to receive said goods, also in the event the delivery, by way of agreement between the Parties, does not occur EXW, Linea Light may proceed to sell the non-collected goods in derogation of that provided for by art. 1515 and subsequent amendments of the Italian Civil Code, without prejudice to any other remedy available by law or by contract, and in particular contemplated by the General Terms.

5. Price - Payment terms and methods

- 5.1. Linea Light reserves the right to make changes to the indicated prices at any time and without prior notice.
- 5.2. The products, unless otherwise agreed in writing between the Parties, shall be supplied at the price indicated in the Linea Light price list in force at the time of acceptance of the order by the latter. Linea Light may freely assign to third parties any trade receivables originating from the supplies. It is hereby specified that the Client must pay the due price in full and on time, even in the event the goods have not yet been collected.
- 5.3. Without prejudice to any other remedy provided for by the agreement, by the General Terms and by the law, or agreed upon between the Parties, in case of delayed payment of the price the Client shall automatically be considered as defaulted and interest shall be accrued on the sums owing at the rate set out in Legislative Decree 231/2002. Moreover, the Client shall immediately forfeit the benefit of the term with reference to all other payments owing to Linea Light, without the need for any prior notification by the latter. Linea Light may suspend all other supplies in favour of said Client until such time as all payments, those in relation to which the delay occurred and any other payments that have become due by way of forfeiture of the benefit of the term, have been fully paid, without prejudice to the fact that if the goods to be delivered have already been produced, the Client shall also be required to pay a sum equal to 0.5% of the price of the non-collected goods for each week or fraction thereof of delay in collection in respect of storage costs, without detriment to the obligation to compensate Linea Light for any additional damages. In all cases referred to in this article 5.2, the Client shall not be able to claim or raise any objections in any capacity and/or for any reason whatsoever.

6. Packaging

- 6.1. Unless otherwise agreed in writing between the Parties, the products shall be delivered with standard Linea Light packaging. Disputes concerning damage to the packaging must, under penalty of forfeiture, be raised in writing by the Client, or by the appointed carrier, upon collection.

7. Guarantees

- 7.1. Linea Light guarantees the Client that the supplied products are free from manufacturing and/or material defects, as well as their conformity to applicable Italian and European regulations in force at the time of delivery. Unless otherwise specifically agreed with an indication of specific regulations to be identified at the risk and peril of the Client, the Client shall bear any risk of the products' non-compliance with other regulations. Linea Light guarantees the products against flaws and defects.
- 7.2. Under penalty of forfeiture, the Client must report any defects found by way of a written communication to Linea Light within 8 days of delivery or upon discovery in the event of a hidden defect. In any case, the Client's warranty rights shall lapse in the event of failure to fulfil its payment obligations in accordance with the agreed terms. Any defect reports must precisely indicate the nature of the defects found, the Linea Light batch number to which the disputed products and any products delivered to third parties or released on the market belong.
- 7.3. The Client, in accordance with the terms set out in article 7.2 above must send the disputed products to Linea Light at its own expense. In the event faults or defects are found to exist for which Linea Light is required to respond according to these General Terms, Linea Light shall see to the replacement of the defective parts at its own expense. In any case, Linea Light shall not be liable in any way to pay compensation for damages, either direct or indirect, suffered by the Client.
- 7.4. The warranty does not cover the normal wear and tear of products and/or defects or malfunctions due to inexperience or use that differs to the Linea Light instructions.
- 7.5. The Client's warranty rights shall also lapse in the event it makes changes or tampers with the products in any way without the prior written authorisation of Linea Light.
- 7.6. The warranty is valid for a period of 24 months from the delivery of the products. Further to the Client's registration on the website www.linealight.com and acceptance of the envisaged terms, the warranty shall be extended to 5 years with effect from the date of the sales invoice.
- 7.7. Variations in the hue of the LED lights (CCT of white light, expressed in Kelvin; wavelength of EM spectrum for coloured light, expressed in nanometres), and variations in the colour of the glass, shall not constitute a flaw and/or defect.

8. Disclaimer

- 8.1. Under no circumstances may Linea Light, which therefore expressly denies all liability, be held responsible for direct and indirect damages, as well as costs and expenses in case of violation of the guarantee referred in article 7 above or any other obligation of Linea Light resulting from the sale of the products.

9. Confidentiality

- 9.1. The Client may not disclose to third parties or use in any way the technical and commercial information of Linea Light, whether written or verbal, regardless of how it is received or assimilated, even if simply on occasion of visits to the Linea Light facilities. Said obligations shall not apply to information, which at the time of its communication by Linea Light or in any case its assimilation by the Client, is legitimately public domain. Said obligations shall remain in force, with reference to all information, until such time as said information becomes public domain.

10. Communications

- 10.1. Any notices or other communication Requested or allowed by the General Terms or by the supply contract, shall be in writing and may be delivered by hand, sent by courier or registered post with return receipt, sent via email or Certified Email (PEC), unless otherwise indicated.





























































11. General provisions

- 11.1. The Client shall not acquire any rights over Linea Light brands and logos by virtue of the supply contract.
- 11.2. Neither Party shall be held responsible for delays or other forms of non-fulfilment of one or more provisions of the General Terms or of the supply contract in the event this is due to force majeure. By way of mere indication, acts of force majeure are considered to be exceptional natural events including earthquakes, floods and the like, collapses, fires, strikes, not only national but also local and corporate, lockouts, riots, acts of terrorism, difficulties in procurement and transport, pandemics, government measures, and, in regards to Linea Light, production downtime due to maintenance works, repairs or refurbishment of systems and properties, also if caused by incorrect or insufficient maintenance works carried out in the past. Said Party shall nonetheless immediately notify the other Party, which shall have the right to withdraw from the Agreement itself in the event the act of force majeure lasts for more than six months.

12. Applicable law and jurisdiction

- 12.1. The General Terms and all supply agreements between Linea Light and Clients shall be regulated by Italian law, with the express exclusion of the Vienna Convention on the international sale of goods (1980) and the conflict of law rules.
- 12.2. All and any disputes arising from the General Terms and/or from any supply agreement, or relative thereto, shall be subject to the exclusive jurisdiction of the Court of Treviso.

Come leggere i simboli / How to read symbols

	Installazione in ambiente interno Indoor installation		Smartwave™
	Installazione in ambiente esterno Outdoor installation		C.C. Constant Current
	Installazione a parete Wall mounting		C.V. Constant Voltage
	Installazione a terra Ground mounting		Dimming con potenziometro integrato Dimming with integrated potentiometer
	Installazione a soffitto Ceiling mounting		Simply DIM
	Installazione a parete o a terra Wall or ground mounting		Phase-cut
	Installazione a soffitto o a parete Ceiling or wall mounting		1-10 V
	Installazione a soffitto, a parete o a terra Ceiling, wall or ground mounting		DALI Digital Addressable Lighting Interface
	Installazione a soffitto o a terra Ceiling or ground mounting		DALI2 Digital Addressable Lighting Interface
	Indice di protezione (IEC 60529) da corpi estranei e acqua Protection index (IEC 60529) against foreign bodies and water		DALI PUSH Digital Addressable Lighting Interface
	Prodotto specificamente studiato per poter resistere ad una immersione temporanea Product designed to withstand temporary immersions		DMX 512
	Indice di protezione sul vano ottico Optical compartment protection index		DMX RDM RDM, DMX 512
	Indice di protezione (IEC 62262) contro impatti meccanici esterni Protection index (IEC 62262) against external mechanical impacts		Infrarosso Infrared
	Apparecchio calpestabile Walkable device		Telecomando a radiofrequenza Radio frequency remote control
	Apparecchio carrabile Carriageable device		Sensore P.I.R. P.I.R. Sensor
	Acciaio inossidabile Stainless steel		Alimentatore con trasformatore di sicurezza Power supply with safety transformer
	Articolo protetto da resina Article protected by resin		Alimentatore indipendente Independent power supply
	Foro d'installazione circolare Circular installation hole		Alimentatore protetto termicamente Thermally protected power supply
	Foro d'installazione quadrangolare Square installation hole		Isolamento rinforzato Reinforced insulation
	Fascio luminoso orientabile Directional light beam		Unified Glare Rating
	Fascio luminoso basculante Tilting light beam		Sensore di movimento Motion sensor
	Disponibile in versione emergenza Emergency version available		Antenna integrata Integrated antenna
	Cavo d'alimentazione incluso Power supply cable included		Antenna esterna External antenna
	Apparecchio idoneo al montaggio su mobili Device suitable to be mounted on furniture		L'alimentatore non passa nel foro di installazione The power supply does not switch into the installation hole
	Apparecchio idoneo al montaggio su superfici normalmente infiammabili (EN 60598) Device suitable to be mounted on normally flammable surfaces (EN 60598)		PointToPoint DALI. Dimmerazione su singolo prodotto PointToPoint DALI. Dimmering on single item
	Apparecchio con protezione termica incorporata Device with built-in thermal protection		Protezione contro le scariche elettriche Electrostatic discharge protection
	Driver incluso Driver included		Protezione contro sovratensioni Over Voltage Protection
	Driver non incluso Driver not included		Versione adatta per zone ATEX 2,22 Version suitable for ATEX 2,22 areas
	Classe I - classe di isolamento elettrico (IEC) Class I - IEC protection class		
	Classe II - classe di isolamento elettrico (IEC) Class II - IEC protection class		
	Classe III - classe di isolamento elettrico (IEC) Class III - IEC protection class		
	T3 Over Voltage Protection		

Tutti gli articoli sono in classe energetica A++.
Gli schemi di collegamento per gli articoli dell'elettronica sono disponibili all'interno della documentazione tecnica.

All articles belong to energy class A++.
The connection diagrams for electronics articles are included in the technical documentation.

Addresses

Linea Light HQ Italy

Via Della Fornace 59
31023 Castelfranco di Resana TV
Italy

+39 0423 7868
info@linealight.com

Linea Light Milano

Via Morimondo 26 int. 17/G
20143 Milano MI
Italy

+39 02 36750915
milano@linealight.com

Linea Light Nord-Est

Via Medoaco 4
c/o Hope Center
35135 Padova PD
Italy
+39 049 7969440
nordest@linealight.com

Linea Light Roma

Via La Spezia, 34
00182 Roma
Italy

+39 06 68589134
info@linealightroma.com

Linea Light UK

Suite205 The business design center
52 Upper Street Islington
N10QH London
United Kingdom
+44 0203 6371983
info@linealight.co.uk

Linea Light France

Rue des Pays-Bas 12
68310 Wittelsheim
France

+33 389 75 52 23
info@linealight.fr

Linea Light Deutschland

Aktienstraße 214
45473 Mülheim an der Ruhr
Germany

+49 208 299979-0
service@linealight.de

Linea Light Greece

538 Vouliagmenis Ave.
17456 Alimos Athens
Greece

+30 210 9940559
g.virinis@linealight.com

Linea Light Spain

C/ Longares, 48
28022 Madrid
Spain

+34 912534773
gestion@linealight.com

Linea Light USA - Inter Lux

3741 Commerce Drive - Suites 306-308
MD21227 Baltimore
USA

+1 410 381 1497
answers@inter-lux.com

Linea Light GCC

P.O. Box 125902
Jumeirah Lake Towers JBC2
35th Floor Office 04
Dubai UAE
+971 4 4218275
info@linealight.ae

Linea Light Asia - Pacific

No. 7, Nanyi Huayuan Road,
Industry Avenue, 528478 Xiaolan Town,
Zhongshan City, Guangdong Province
China
+86 760 87618355
info@linealight.com.cn

Linea Light Singapore

21 Kaki Bukit Place, 5th Fl.
416199 Singapore
Singapore

+65 6908 5758
info.sg@linealight.com

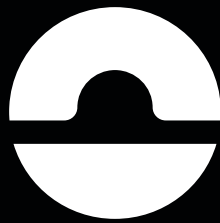

LIGHT UP NEW IDEAS!

linealight.com